

AFFETTATRICI A GRAVITÀ

CE PROFESSIONALE

Swedlinghaus dal 1950®





STANDARD



SILVER



CE

-  Belt driven gravity slicers
-  Trancheurs gravité à courroie
-  Schwerkraft - Aufschnittmaschinen
-  Cortadoras de fiambres de gravedad

AF 350 GR
AF 370 GR



GLI OPTIONALS

- 1. VERNICIATURA (COLORI RAL)**
RAL colours painting
Vernis couleurs RAL
Lackierung (RAL Farben)
Pintura colores RAL
- 2. VERNICIATURA CON FILETTATURA ORO**
RAL colours painting with gold border
Vernis couleurs RAL et bordure or
Lackierung mit Goldgewinde
Pintura con fileteado oro
- 3. MICRO SU PARALAMA**
Blade guard plate micro switch
Micro-interrupteur de sécurité de disque couvre lame
Mikroschalter auf Messerverschluss
Microinterruptor de seguridad en protector de cuchilla
- 4. MOTORE 24 V E VOLTAGGI SPECIALI**
24V Motor and special voltages
Moteur 24V et voltages spéciales
24V Motor und Sonderspannungen
Motor 24V y voltajes especiales
- 5. LAMA GB**
GB blade
Lame GB
GB Klinge
Cuchilla GB
- 6. LAMA TEFLONATA**
Teflon blade
Lame Téflon
Klinge aus Teflon
Cuchilla Teflón
- 7. LAMA DENTATA**
Toothed blade
Lame dentée
Gezahnte Klinge
Cuchilla dentada
- 8. ESTRATTORE LAMA**
Blade extractor
Extracteur lame
Messersabzieher
Extractor de cuchilla
- 9. BILANCIA SOLO PESO**
Weight-only scale
Balance poids uniquement
Gewichtswaage
Balanza solo peso
- 10. PRODOTTO DI PULIZIA**
Cleansing detergent
Detergent
Reinigungsmittel
Producto de limpieza

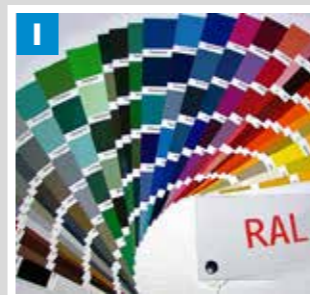

Swedlinghaus®

SWEDLINGHAUS srl • sede centrale
via Enrico Berlinguer, 5
63844 Grottazzolina (FM) • ITALY

Filiale Nord
via Puccini, 11/B
21012 Cassano Magnago (VA) • ITALY

Tel. +39.(0)734.631346
Fax +39.(0)734.632560
e. mail: info@swedlinghaus.it

www.swedlinghaus.it

AFFETTATRICI A GRAVITÀ

mod. AF 350 GR • mod. AF 370 GR

Affettatrici a gravità professionali, ideali per il taglio dei salumi. Fusione in lega di alluminio anodizzato, trasmissione a cinghia, motore con termica di protezione, lama forgiata in acciaio temperato, scorrimento carrello su boccole autolubrificanti, piatto portamerce in alluminio dotato di canalini di scorrimento, sistema di sblocco piatto di serie (versione CE), affilatoio incorporato in fusione di alluminio. Disponibile anche nella versione con manopole completamente in alluminio anodizzato (SILVER).

 Gravity slicers recommended for professional use. Anodized cast aluminium alloy, belt driven transmission, motor thermal protection, forged and hardened steel blade, carriage running on self-lubricating bushes, aluminium feed plate equipped with special sliding grooves, carriage release device (CE version), cast-in sharpener assembly. Also available with anodized aluminium knobs (Silver version).

 Trancheurs gravité recommandés pour l'usage professionnel. Réalisé en fusion d'alliage d'aluminium anodisé, transmission à courroie, moteur avec protection thermique lame en acier trempé et forgé, coulissement du chariot sur bagues autolubrifiantes, plateau porte-produit en aluminium avec glissières, dispositif de déblocage du chariot (Version CE), affûteur aluminium incorporé. Disponible avec poignées en aluminium anodisée (Version Silver).

 Professionelle Schwerkraft-Aufschnittsmaschinen, ideal zum Schnitt von Wurstwaren. Schmelzen aus eloxierter Aluminiumlegierung, Riementrieb, Motorschutzrelais, geschmiedete Klinge aus gehärtetem Stahl, Gleitung des Schneidegutschlittens auf selbstschmierenden Buchsen, Schlittentisch aus Aluminium, mit für ein einfacheres Gleiten kleinen Riefen versehen, serienmässiges System zur Entriegelung des Schlittentisches (CE Version), eingebauter Messerschärfer aus Aluminiumschmelzen. Auch in der Version mit Einstellknöpfen voll aus Edelstahl verfügbar (SILVER Version).

 Cortadoras de gravedad profesionales, ideales para el corte de fiambres. Fundición de aleación de aluminio anodizado, transmisión a correa, motor con llave térmica de protección, cuchilla forjada en acero templado, con deslizamiento del carro sobre aros autolubricantes, plato contenedor de fiambre de aluminio dotado de canales de deslizamiento que disminuyen la fricción, sistema de desbloqueo plato de serie (versión CE), afilador incorporado en fundición de aluminio. Disponible también en la versión con empuñaduras de aluminio anodizado (versión SILVER).

LA SCHEDA TECNICA

- A DISTANZA PIEDINI**
Distance between feet / Distance entre les pieds
Abstand zwischen der Füßchen / Distancia entre los pies
- B INGOMBRO TAGLIO**
Max overall dimension during cutting operation / Dimension max pendant le coupe
Platzbedarf beim Schneiden / Distancia máxima en la fase de corte
- C INGOMBRO MAX INIZIO/FINE CORSA**
Max distance beginning-end movement / Max distance début-fin mouvement
Maximaler Platzbedarf Beginn-Ende der Bewegung / Distancia máxima inicio-fin recorrido
- D DISTANZA PIEDINI**
Distance between feet / Distance entre les pieds
Abstand zwischen der Füßchen / Distancia entre los pies
- E INGOMBRO MASSIMO IN LARGHEZZA**
Overall width dimension / Dimension d'encombrement largeur
Maximaler Platzbedarf-Breite / Medida ancho máximo
- F ALTEZZA**
Height / Hauteur / Höhe / Altura
- G INGOMBRO MASSIMO IN ALTEZZA**
Overall height dimension / Dimension d'encombrement hauteur
Maximaler Platzbedarf-Höhe / Medida altura máxima

	AF 350 GR	AF 370 GR
A	620 mm	620 mm
B	695 mm	695 mm
C	770 mm	770 mm
D	445 mm	445 mm
E	580 mm	580 mm
F	500 mm	510 mm
G	640 mm	640 mm

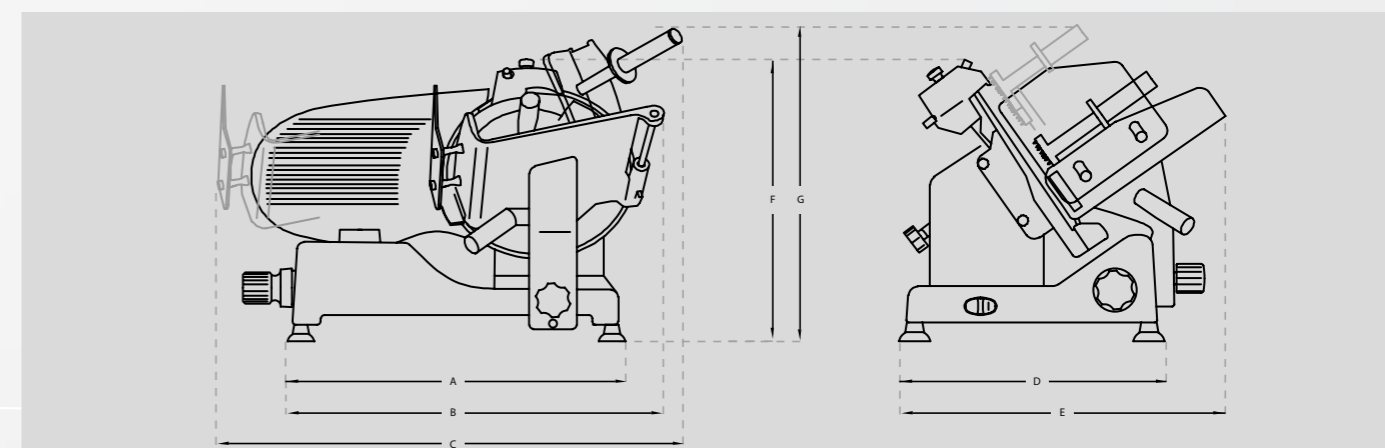

MODELLO	AF 350 GR	AF 370 GR
CAPACITÀ TAGLIO Cutting capacity / Capacité de coupe Schneidleistung / Capacidad de corte	□ 300x260 mm ○ 260 mm	□ 300x270 mm ○ 270 mm
SPESSORE DI TAGLIO Cutting thickness / Épaisseur de coupe Schnittdicke / Espesor del corte	0÷16 mm	0÷16 mm
PESO Weight / Poids / Gewicht / Peso	42 kg	43 kg
MOTORE Motor / Moteur / Motor / Motor	0,37 kw	0,37 kw
LAMA DIAMETRO Blade / Lame Messerdurchmesser / Cuchilla	350 mm	370 mm
DIMENSIONI PIATTO Carriage dimensions / Dimensions plateau Ausmasse des Schlittentisches / Dimensiones plato	315x280 mm	315x280 mm
DIMENSIONI IMBALLO Packing dimensions / Dimensions emballage Ausmass der Verpackung / Dimensiones embalaje	650x800x610 mm	650x800x610 mm

LE ALTRE VERSIONI

1. AFFETTATRICE TEFLON

Teflon coated slicer - Trancheur Téflon - Aufschnittmaschine aus Teflon - Cortadora de fiambres Téflon

2. AFFETTATRICE TOP

Top Series slicer - Trancheur Série Top - Aufschnittmaschine Top Serie - Cortadora de fiambres Serie Top

